

Molecular evidence for deep evolutionary roots of bilaterality in animal development

David Q. Matus*, Kevin Pang*, Heather Marlow*, Casey W. Dunn*, Gerald H. Thomsen†, and Mark Q. Martindale**

*Kewalo Marine Laboratory, Pacific Bioscience Research Center, University of Hawaii, 41 Ahui Street, Honolulu, HI 96813; and †Department of Biochemistry and Cell Biology, Center for Developmental Genetics, Stony Brook University, Stony Brook, NY 11794-5215

Edited by John B. Gurdon, University of Cambridge, Cambridge, United Kingdom, and approved May 26, 2006 (received for review February 23, 2006)

Nearly all metazoans show signs of bilaterality, yet it is believed the bilaterians arose from radially symmetric forms hundreds of millions of years ago. Cnidarians (corals, sea anemones, and “jellyfish”) diverged from other animals before the radiation of the Bilateria. They are diploblastic and are often characterized as being radially symmetrical around their longitudinal (oral–aboral) axis. We have studied the deployment of orthologs of a number of family members of developmental regulatory genes that are expressed asymmetrically during bilaterian embryogenesis from the sea anemone, *Nematostella vectensis*. The secreted TGF- β genes *Nv-dpp*, *Nv-BMP5–8*, six TGF- β antagonists (*NvChordin*, *NvNoggin1*, *NvNoggin2*, *NvGremlin*, *NvFollistatin*, and *NvFollistatin-like*), the homeodomain proteins *NvGooseoid* (*NvGsc*) and *NvGbx*, and the secreted guidance factor, *NvNetrin*, were studied. *NvDpp*, *NvChordin*, *NvNoggin1*, *NvGsc*, and *NvNetrin* are expressed asymmetrically along the axis perpendicular to the oral–aboral axis, the directive axis. Furthermore, *NvGbx*, and *NvChordin* are expressed in restricted domains on the left and right sides of the body, suggesting that the directive axis is homologous with the bilaterian dorsal–ventral axis. The asymmetric expression of *NvNoggin1* and *NvGsc* appear to be maintained by the canonical *Wnt* signaling pathway. The asymmetric expression of *NvNoggin1*, *NvNetrin*, and *Hox* orthologs *NvAnthox7*, *NvAnthox8*, *NvAnthox1a*, and *NvAnthox6*, in conjunction with the observation that *NvNoggin1* is able to induce a secondary axis in *Xenopus* embryos argues that *N. vectensis* could possess antecedents of the organization of the bilaterian central nervous system.

Cnidarians, ctenophores, and placozoans are animal groups thought to have diverged from the rest of the Metazoa, the Bilateria, before the origins of triploblasty and bilateral symmetry (1–5). Although examples of bilaterality have been described at a morphological level in many cnidarians (6–8), it has been difficult to homologize relationships between cnidarian body axes with those of bilaterian metazoans. Anthozoans such as *Nematostella vectensis* have been described as being bilaterally symmetrical (7, 8) because of the anatomy of internal mesenteries and the position of a ciliated groove in the animal’s pharynx (the siphonoglyph). The plane of bilateral symmetry that runs perpendicular to and includes the oral–aboral axis is called the “directive axis” (Fig. 1 B–D). Previous assertions of the homology of the directive axis to any bilaterian axis rest on the expression of a single *N. vectensis* gene, *NvDpp* (9) (an ortholog of *dpp/BMP2/BMP4*) which, along with its antagonist, *sog/chordin*, is causally involved with establishing the dorsal–ventral (D–V) axis of *Drosophila* and vertebrates (10, 11).

Although differences exist in the initial symmetry-breaking events in different bilaterians, e.g., regionalized dorsal in *Drosophila* (12), and β -catenin in vertebrates (11, 13), at least one conserved aspect of the patterning of the D–V axis in both protostomes and deuterostomes appears to be the antagonistic interaction of diffusible extracellular ligands of the TGF- β superfamily (*BMP2/BMP4/dpp*) and their antagonists (e.g., *chordin/sog*). With sampling mostly from within the Ecdysozoa (*Drosophila* and *Caenorhabditis elegans*) and within the deuterostomes (echinoderms and chordates), it appears that deuterostomes have diversified both the number of interacting ligands [nodals, bone morphogenetic proteins (BMPs),

growth differentiation factors, and TGF- β s] and antagonists (*noggin*, *follistatin*, *gremlin*, and *cerberus*). Many of these genes in vertebrates are expressed asymmetrically in the dorsal lip of the blastopore during gastrulation (i.e., the Spemann Organizer) and have been shown to be causally involved in the elaboration of D–V features (11). Other genes, including the homeodomain transcription factors *gooseoid* (*Gsc*) and *gastrulation brain homeodomain* (*Gbx*), are also expressed either in the dorsal lip during gastrulation (*Gsc*) or involved in patterning the brain (*Gbx*) (14–17).

We have cloned a number of developmental genes responsible for generating bilaterality in other systems, including TGF- β family members, their antagonists, and other classical “organizer” genes (11, 18), a feat facilitated by the recent sequencing of the *N. vectensis* genome (by the Department of Energy Joint Genome Institute, Walnut Creek, CA). Genome coverage is currently at about five times, which indicates that only 0.6% has not yet been sequenced (19). In addition to previously reported *NvDpp* (BMP2/BMP4) and *NvGDF5-like* (9), orthologs to four other TGF- β ligands have been recovered (20, 21). However, no orthologs of the TGF- β family members *nodal*, a gene required for mesendoderm formation in chordates (22, 23), or *lefty/antivin*, a gene involved in chordate left-right asymmetry (22), have been detected in cnidarians, suggesting that these genes arose after the cnidarian–bilaterian divergence or have been lost in the Cnidaria. We identified orthologs to several BMP antagonists that are asymmetrically expressed in the dorsal lip of the vertebrate embryonic blastopore (Fig. 1A): *chordin/sog* (*NvChordin*), two *noggins* (*NvNoggin1* and *NvNoggin2*), two *follistatins* (*NvFollistatin* and *NvFollistatin-like*), and *NvGremlin* (all of which bind TGF- β ligands extracellularly) (11), but an ortholog of *Cerberus* (another potent TGF- β inhibitor) does not appear to be present in *N. vectensis*. We also recovered the homeodomain genes *Gsc* (*NvGsc*) and *Gbx* (*NvGbx*). Thus, cnidarians have many, but not all, of the genes involved in vertebrate D–V patterning and substantially more than ecdysozoan protostomes. No protostome taxon to date has been shown to possess all four orthologs for BMP antagonists: *noggin*, *chordin*, *follistatin*, and *gremlin* (24), consistent with other studies showing that the lower diversity of some gene families in the model ecdysozoans is not caused by the expansion of these families in the deuterostomes, but by reduction in the ecdysozoans (20, 25, 26).

NvDpp and *NvBMP5–8* are the only TGF- β ligands expressed during gastrulation in *N. vectensis* (21). Along with their antagonist *NvChordin*, all three are initially coexpressed asymmetrically at the onset of gastrulation (9, 21). Their main function at gastrulation appears to regulate germ-layer segregation and/or early epithelial patterning rather than D–V polarity (21). Additionally, because morphological asymmetries do not appear until later in develop-

Conflict of interest statement: No conflicts declared.

This paper was submitted directly (Track II) to the PNAS office.

Abbreviations: BMP, bone morphogenetic protein; D–V, dorsal–ventral.

Data deposition: The sequences reported in this paper have been deposited in the GenBank database (accession nos. DQ517920–DQ517928).

†To whom correspondence should be addressed. E-mail: mqmartin@hawaii.edu.

© 2006 by The National Academy of Sciences of the USA

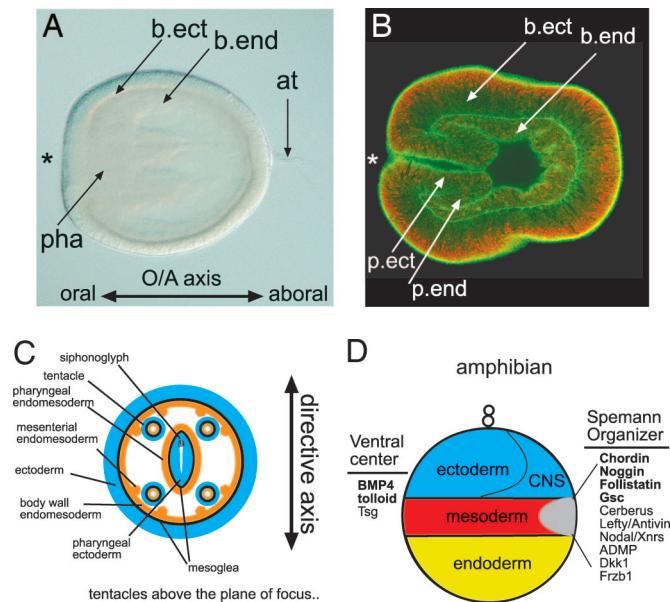

Fig. 1. Body plan of the anemone *N. vectensis*. (A and B) Micrographs of a lateral view of a planula-stage *N. vectensis* embryo. (A) Differential interference contrast micrograph. (B) Confocal micrograph with F-actin (green) and nuclei (red) stained with BODIPY-phalloidin and propidium iodide. The asterisk marks the blastopore and site of the future mouth. at, apical tuft; b.end, body wall endoderm; b.ect, body wall ectoderm; pha, pharynx; p.end, pharyngeal endoderm; p.ect, pharyngeal ectoderm. (C) Cross-sectional diagram of the *N. vectensis* body plan showing the different germ layers. (D) Diagram of a fate map for an amphibian embryo indicating the positions of ectodermal (including the CNS), mesodermal, and endodermal germ layers and some of the signaling molecules located on the ventral and dorsal (Spemann Organizer) sides involved in D-V polarity formation. Orthologs of some of the genes examined in this study are in bold. (Magnifications: $\times 100$.)

ment in *N. vectensis*, it is unknown how the initial asymmetric expression of these genes at gastrulation relates to the adult body plan. We have studied the deployment of candidate bilaterian D-V patterning genes to determine whether any are expressed asymmetrically during the development of this anthozoan.

Results

TGF- β Antagonist Expression. After gastrulation *NvChordin* is expressed around the entire oral pole (21), but its expression becomes restricted to a “W”-shaped ectodermal pattern on one side of the

Fig. 2. Expression of four TGF- β antagonists during *N. vectensis* planula development. (A) *NvAnthox8* is expressed asymmetrically along the directive axis, in body wall endoderm on one pole, and in a small cluster of cells in the pharyngeal endoderm on the opposite pole. (B) Double-label *in situ* hybridization showing asymmetric ectodermal expression of *NvChordin* on the side opposite of body wall endodermal Hox (*NvAnthox8*) expression. (C) *NvFollistatin* is expressed in pharyngeal endoderm in a ring in planula stages. (D and E) *NvNoggin1* is expressed at the base and tips of growing tentacles (ten), in the endoderm below the apical tuft, and in the pharyngeal endoderm along one side of the directive axis, marking the site of the siphonoglyph. (F and G) Double-label *in situ* hybridization showing that the asymmetric pharyngeal endoderm expression of *NvNoggin* is on the side opposite of Hox gene expression (*NvAnthox8*). (G) *NvNoggin1* is also expressed in the endoderm and ectoderm of the apical tuft at this stage of development. (H) *NvGremlin* is expressed in a ring of endodermal cells around the mouth on the oral pole on the polyp. The asterisk denotes the site of the blastopore and mouth. All embryo views are oral, except C, D, G, and H, which are lateral views, anterior to the left. (Magnifications: $\times 100$.)

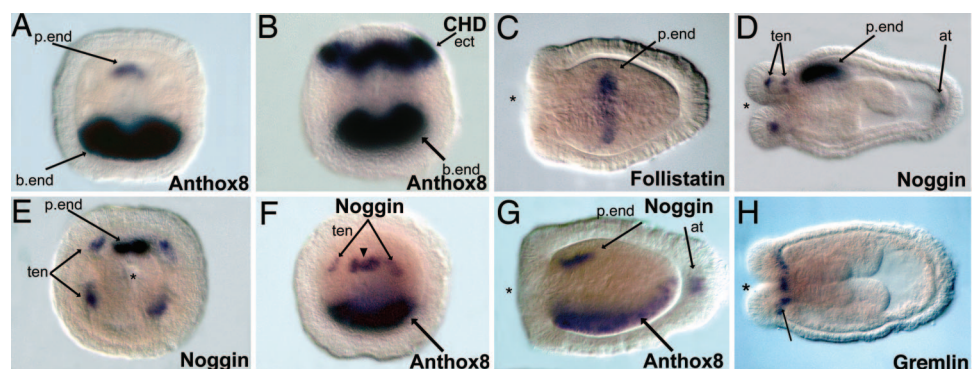

mouth during early planula stages (Fig. 2B and Fig. 8A, which is published as supporting information on the PNAS web site). Double-label *in situ* hybridizations show that this asymmetric ectodermal *NvChordin* expression is on the opposite side of longitudinal body wall endodermal Hox gene expression (*NvAnthox8*; Fig. 2B and see Fig. 7A), but on the same side as *NvDpp* expression in pharyngeal ectoderm (9) (Fig. 8E). *NvChordin* and *NvDpp* expression are down-regulated in oral/pharyngeal ectoderm by mid-planula stages. Therefore, at early planula stages, the transient ectodermal *NvChordin* and *NvDpp* expression associated with the pharynx define a single pole of the directive axis of the embryo (see Fig. 7).

In most vertebrate embryos *goosecoid*, *noggin*, and *follistatin* are typically expressed asymmetrically along with *chordin* at gastrulation in the dorsal blastopore lip (Fig. 1D) (11, 17, 27, 28). In *N. vectensis*, however, this is not the case. *NvFollistatin-like* is expressed throughout the endoderm after its invagination at gastrulation (Fig. 9 G–I, which is published as supporting information on the PNAS web site), but orthologs to the two *noggin* genes (*NvNoggin1* and *NvNoggin2*) and *follistatin* (*NvFollistatin*) are not yet expressed. At early planula stages *NvNoggin1* (Fig. 2 D and E) and *NvGsc* (Fig. 3 A–D) are expressed in a highly asymmetric manner along the directive axis, whereas *NvFollistatin* is expressed in a ring of pharyngeal endoderm (Figs. 2C and 9) and *NvNoggin2* is expressed weakly throughout the endoderm (Fig. 10, which is published as supporting information on the PNAS web site). *NvNoggin1* is expressed strongly in endoderm on only one side of the pharynx above the position where the ciliated siphonoglyph will form (Fig. 2 D and E) from midplanula stages through adult polyp formation and in the endodermal base and tips of the developing tentacles (Fig. 2D). Double-label *in situ* staining experiments show that *NvNoggin1* (Fig. 2 F and G), *NvDpp* (9), and *NvChordin* (Fig. 2B) are expressed on the same pole of the directive axis, whereas the Hox genes *NvAnthox8* (Fig. 2A), *NvAnthox7*, *NvAnthox1a* (Fig. 3E), and *NvGDF5-like* (9) are expressed along the opposite pole (see Fig. 7). *NvNoggin1* is also coordinately expressed with the TGF- β member, *NvActivin*, in the endoderm of developing tentacle buds and around the oral pole (Fig. 11, which is published as supporting information on the PNAS web site) and may be involved in epithelial growth or morphogenesis (29).

Although no ortholog to *Cerberus*, a BMP antagonist expressed in the Spemann Organizer (30), was recovered, we did isolate an ortholog to a related DAN-family BMP antagonist, *NvGremlin* (Fig. 12, which is published as supporting information on the PNAS web site). *NvGremlin* is not expressed during gastrulation, but is only expressed in an endodermal ring around the mouth during polyp formation (Fig. 2H). In vertebrates, *gremlin* orthologs are BMP2/

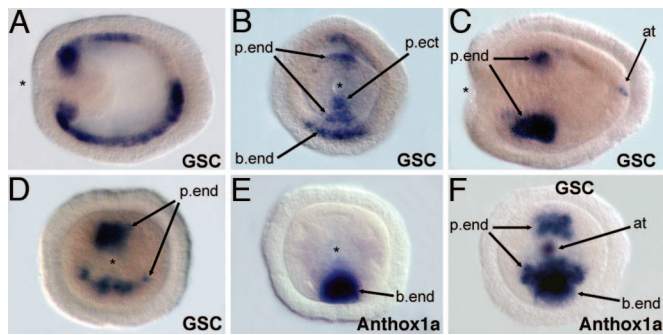

Fig. 3. *Gsc* is asymmetrically expressed along the directive axis during development. (A and B) *NvGooseoid* (*gsc*) is expressed initially in body wall endoderm (b.end) (A) and pharyngeal endoderm (p.end) and ectoderm (p.ect) (B). (C and D) During planula stages, *NvGsc* is expressed in pharyngeal endoderm, asymmetrically along the directive axis, and in the endoderm below the apical tuft (at) (C). (E) *NvAnthox1a* is expressed in body wall endoderm on one pole of the directive axis. (F) Double-label *in situ* hybridization showing that the larger domain of *NvGsc* pharyngeal endoderm expression is on the same pole of the directive axis as *Hox* expression (*NvAnthox1a*). The asterisk denotes the site of the blastopore and mouth. All embryo views are oral, except A and C, which are lateral views, anterior to the left. (Magnifications: $\times 100$.)

BMP4/BMP7 inhibitors, and in *N. vectensis*, *NvDpp* and *NvBMP5–8* are expressed pan-endodermally during polyp stages, indicating that circumoral inhibition of BMP signaling may be occurring.

Gooseoid Is Expressed Asymmetrically Along the Directive Axis. In several bilaterians surveyed (14, 31–34) the homeodomain gene *Gsc* has been characterized as a blastopore and anterior foregut marker; however, *Gsc* expression has not been characterized during embryogenesis outside of the Bilateria, although it has been shown to function as a head patterning gene in adult *Hydra* (35). In *N. vectensis*, *NvGsc* is not expressed during gastrulation, but is initially expressed transiently in diametrically opposed domains of body wall endoderm and pharyngeal endoderm and ectoderm during early planula stages (Fig. 3A and B). Later, *NvGsc* expression is restricted to pharyngeal endoderm at each pole of the directive axis but is expressed more strongly along the *Hox*-expressing pole (Fig. 3C and D) perhaps similar to asymmetric *gsc* expression in bilaterian foreguts (31, 32, 34).

Other Genes Supporting the Bilateral Body Plan Organization. *NvGbx* is expressed in two parallel longitudinal stripes in body wall endoderm during early planula stages (Fig. 4A). Later in development, transcripts disappear but new expression appears in two symmetric domains in pharyngeal endoderm (Fig. 4A–C). Double-

label *in situ* show that unlike all other described genes that are expressed along one or both poles of the directive axis, *NvGbx* expression is bilateral, flanking the directive axis on the left and right sides (Fig. 4D and E). In vertebrates *Gbx* shows bilateral expression domains in mesendoderm flanking the neural tube and in neuroectoderm (16). *NvChordin* is also expressed along the left-right axis, in two bilateral patches in pharyngeal endoderm during later polyp stages, flanking *NvNoggin1* expression at the base of the first two mesenteries (Fig. 4F). Thus, *N. vectensis* expresses gene products in left and right domains, perpendicular to the directive axis (see Fig. 7). We have not yet detected any evidence for left-right asymmetry, which in deuterostomes may have evolved under the influence of nodal-related genes and their regulators (e.g., *lefty/antivin*, *Cerberus*, and *caronte*; ref. 22).

The Guidance Molecule Netrin Is Expressed Asymmetrically Along the Directive Axis. Netrins are a family of secreted guidance factors, which can attract or repulse migrating neurons and neuronal growth cones depending on the context of the signal and the particular receptor binding the netrin ligand (36) in a diverse array of bilaterians (36–41). In protostomes, *netrin* is expressed at the ventral midline, and in the chordates, *netrin* is expressed in the ventral region of the dorsal nerve cord (the embryonic dorsal pole) (36–41), which has led some authors to argue for D-V inversion of body plan organization in these groups (42). The *N. vectensis* ortholog of bilaterian netrin, *NvNetrin* (Fig. 13, which is published as supporting information on the PNAS web site), is expressed asymmetrically in the developing pharynx and body wall endoderm, during early planula development (Fig. 5A and B), and in a group of ectodermal cells forming the apical tuft, a sensory structure that also expresses other neural genes such as *NvCOE* (43). Double-label *in situ* hybridizations show that *NvNetrin* is coexpressed asymmetrically in the body wall endoderm with a number of *Hox* genes (Fig. 5C–F). During late planula and polyp development, *NvNetrin* shifts from an asymmetric expression pattern to a circumoral endodermal ring and to the endodermal tips of the growing tentacles, the latter staining coincident with *NvNoggin1* expression (Fig. 5G and H).

Lithium Chloride Treatment Radializes Organizer Gene Expression. Lithium chloride has been used as a teratological agent to affect embryological development for well over a century (e.g., ref. 44). In *N. vectensis*, chronic lithium chloride treatment radializes the normally asymmetric pharyngeal expression of *NvNoggin1* (Fig. 6A and B) and *NvGsc* (Fig. 6C). The radializing affect of lithium chloride appears to be conserved in other metazoans such as sea urchins (45) and in amphibians (46, 47). Lithium chloride affects the canonical *Wnt* signaling pathway that may be involved in maintaining asymmetric gene expression during early *N. vectensis*

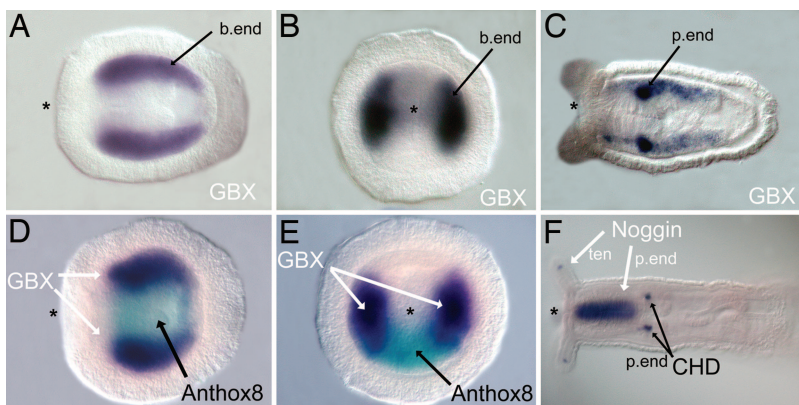

Fig. 4. Left/right expression of genes during *Nematostella* development defines a third body axis. (A–C) *NvGbx* is expressed bilaterally in body wall endoderm (b.end) (A and B) and pharyngeal endoderm (p.end) (C). (D and E) Double-label *in situ* hybridization shows that *NvGbx* (purple) is expressed along the left-right axis, bilaterally, flanking *NvAnthox8* (turquoise) expression in planula-stage embryos. (F) Double-label *in situ* hybridization showing the latest expression of *NvChordin* in polyp-stage embryos. *NvChordin* is expressed in two bilateral patches of cells to the left and right of the siphonoglyph *NvNoggin1* expression. The asterisk denotes the mouth. All embryo views are lateral with anterior to the left, except B and E, which are oral views. (Magnifications: $\times 100$.)

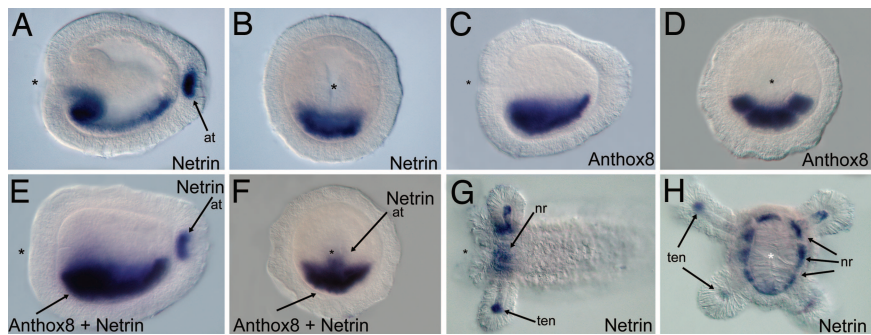

Fig. 5. *NvNetrin* is expressed asymmetrically with *Hox* genes in the endoderm during planula development. (A and B) *NvNetrin* is expressed asymmetrically during planula development in the body wall endoderm, in a longitudinal stripe, and in a few ectodermal cells at the base of the apical tuft (at). (C–F) Double-label *in situ* hybridization shows that *NvNetrin1* is coexpressed with *NvAnthox8* in the body wall endoderm. (G and H) During polyp development, *NvNetrin* expression is in a ring around the mouth (nr). The endodermal tips of the tentacles (tn) also express *NvNetrin1* (G). Tentacles are out of the plane of focus in H. The asterisk denotes the site of the blastopore and mouth. All embryo views are lateral, with anterior to the left, except B, D, F, and H, which are oral views. (Magnifications: $\times 100$.)

planula development and the molecular patterning of the directive axis.

***N. vectensis* Genes Have Conserved Biological Activity.** The developmental regulatory genes studied here were identified by sequence similarity, and their orthology assignments were supported by phylogenetic analysis (Figs. 12–16, which are published as supporting information on the PNAS web site). One would anticipate that these genes would have similar activity as their vertebrate counterparts. TGF- β antagonists have no known function other than to inhibit TGF- β signaling (i.e., they are not ligands for their own signal-transducing receptors), and they are considered to be proneural in all organisms studied (11, 18, 48). As a test of whether *N. vectensis* orthologs have conserved function with vertebrate orthologs we expressed *NvNoggin1* in *Xenopus laevis* embryos. Injections of synthetic mRNA for *NvNoggin1* into the ventral marginal zone of the early blastula generated an ectopic dorsal axis identical to ones induced by ectopic expression of *Xenopus* *Noggin* (Fig. 17, which is published as supporting information on the PNAS web site), a result characteristic of BMP inhibition. We continued to test other components of the *N. vectensis* TGF- β system for homologous function in *Xenopus* assays, but the results indicate that the components and function of the TGF- β agonist–antagonist system were well diversified in the bilaterian–cnidarian ancestor and the differential regulation of these conserved genes could play important patterning roles during development (49).

Discussion

Evolutionary Predecessor of the D-V Axis? The asymmetric expression of such a large number of both transcription factor and secreted gene families in multiple tissues along the *N. vectensis* directive axis indicates that these animals have a great deal of spatial complexity that is not readily apparent at the morphological level (Fig. 7). The fact that *NvChordin*, *NvNoggin1*, *NvGsc*, and *NvDpp* all are expressed asymmetrically along the directive axis at some point in the development of the juvenile body suggests that the cnidarian directive axis might be homologous to the bilaterian D-V axis (Fig. 7). In bilaterians, TGF- β ligands and antagonists are expressed at opposite poles of the D-V axis (11), whereas in *N. vectensis*, TGF- β ligand and antagonist asymmetric gene expression is confined to domains within the pharynx, at the ciliated siphonoglyph pole of the

directive axis. In vertebrates, *chordin*, *noggin*, *folllistatin*, and *goosecoid* are coexpressed asymmetrically in dorsal mesoderm during early stages of gastrulation (Fig. 1D) (11, 17, 28), but *N. vectensis* does not have definitive mesoderm, and *NvGsc*, *NvNoggin1*, and *NvFollistatin* are not expressed until after gastrulation is complete. The earliest expression of *NvChordin* is confined to oral ectoderm and may be playing a role in germ-layer segregation (21). In vertebrates, all three secreted TGF- β inhibitors (*noggin*, *chordin*, and *folllistatin*) are required coincidentally in the dorsal lip to function as a dorsal organizer (48). This requirement indicates that a heterochronic shift in the deployment of TGF- β antagonists and other organizer genes during gastrulation may have occurred in bilaterians and that in cnidarians these genes may function initially in establishing germ-layer identity (21) and later in development play a role in axial patterning. *NvFollistatin-like* (Fig. 9 G–I), and *NvNoggin2* (a cnidarian-specific gene duplication; Fig. 8) are expressed uniformly in the endoderm, and during gastrulation *NvChordin* is expressed topographically in an area separating ectoderm from endoderm (21). Arguments have been made that mesoderm evolved from a bifunctional mesendoderm, so it might be that regulation of TGF- β signaling [e.g., via *nodal*-related genes (22, 23)] was involved with the evolution of a definitive mesodermal germ layer (50, 51) and additional genes were recruited for mesodermal patterning at later stages of metazoan radiations. However, an alternative hypothesis would be that some of these genes played a role in D-V patterning in the common ancestor of cnidarians and bilaterians, and that this role has been reduced in some cnidarians. The radializing affects of lithium chloride on *NvNoggin* and *NvGsc* (Fig. 6), both asymmetrically deployed in the pharynx along the directive axis during normal development (Fig. 7), suggests that the secondary radialization from a bilaterally symmetrical body plan in some forms may be related to changes in the canonical *Wnt* signaling pathway.

A number of genes are associated with the development of the anterior end of bilaterian animals, in particular with anterior neural and foregut structures. *NvGbx* expression in bilateral patches along body wall endoderm (Fig. 4A) is reminiscent of the bilateral endomesodermal expression in the head region of vertebrates (16). *NvGbx* disappears in body wall endoderm (as does endomesodermal expression in vertebrates) (16) and reappears in two bilateral patches of the pharynx (Fig. 4C). In vertebrates, *gbx* staining persists

Fig. 6. Lithium chloride treatment radializes expression of organizer genes. Ectopical activation of the canonical *Wnt* pathway by lithium chloride treatment radializes *NvNoggin1* (A and B) and *NvGsc* (C) expression. *NvNoggin1* is normally expressed in tentacle endoderm, at the base of the apical tuft, and asymmetrically along one side of the directive axis, marking the site of the future siphonoglyph. *NvNoggin1* is expressed in an endodermal ring at the oral pole in lithium-treated embryos (A and B). *NvGsc* is normally expressed asymmetrically along the directive axis in the pharyngeal endoderm, with a larger domain of expression on one pole. *NvGsc* is expressed symmetrically in body wall endoderm and in the pharynx of lithium-treated embryos (C). (Magnifications: $\times 125$.)

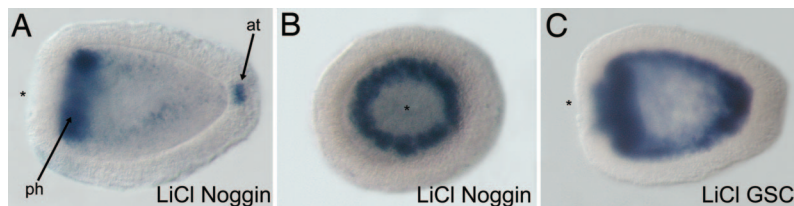

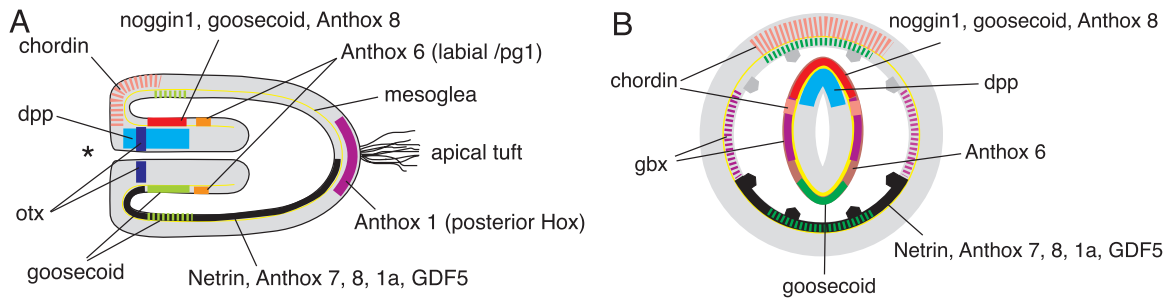

Fig. 7. Summary of asymmetric gene expression patterns during development in *N. vectensis*. (A) Lateral view with the oral (anterior) pole toward the left. (B) Cross section through the pharynx. Asterisk marks the site of gastrulation and mouth. The mesoglea (yellow line) separates the ectodermal epidermis from the endodermal gastrodermis. Colored bars represent different gene expression patterns, with hash-marked color bars representing transient early gene expression. Tentacle and apical tuft expression is not shown for clarity. A suite of bilaterian patterning genes (transcription factors, secreted ligands, and their antagonists) is dynamically expressed along both the oral/aboral axis and the directive axis in both germ layers. The asymmetric expression of *NvChordin*, *NvDpp*, *NvNoggin*, and *NvAnthox8* in the pharynx on the side opposite the expression of *NvNetrin*, three Hox genes, the larger domain of *NvGsc*, and *NvGDF5*-like, suggests homology of the directive axis to the D-V axis of bilaterians. The bilateral expression of *NvGbx* and *NvChordin* marks the left-right axis.

in the hindbrain where it interacts with *otx*, *FGF*, and *wnt8* genes to establish the midbrain–hindbrain boundary (16, 52). The *N. vectensis* ortholog of *Wnt8*, *NvWnt8*, is expressed in endoderm surrounding the pharynx (26), and *Otx* genes are expressed at the oral end of the pharynx (and in the tentacle buds) (K.P. and M.Q.M., unpublished work), suggesting that the oral pole of anthozoans is homologous to the bilaterian anterior (not posterior or ventral) pole (9, 53). Because the mouth, the single opening to the gut, forms at the site of gastrulation (at the animal pole), *N. vectensis*, is by definition, a true “protostome,” indicating that protostomy predates the cnidarian–bilaterian divergence.

Function of Asymmetrically Expressed Genes. In both flies and vertebrates, inhibitors of TGF- β signaling (e.g., *noggin*, *chordin*, *folliculin*, and *gremlin*) promote neural differentiation (11). In *N. vectensis* embryos the TGF- β inhibitors *NvNoggin1* and *NvChordin* are expressed asymmetrically in the pharynx throughout late planula and polyp stages (Figs. 2D and E and 4F). At least one of these genes, *NvNoggin1* has BMP antagonistic activity when tested in the amphibian ectopic dorsalization assay (Fig. 17) just as its ortholog does in vertebrates (54, 55). Among metazoan model organisms, BMP antagonists have been shown to affect body pattern by affecting graded BMP activities. These antagonists also act synergistically with mitogen-activated protein (MAP) kinase signals to specify primary neural cell fate, with the MAP kinase signals provided by secreted FGF ligands in vertebrates (11, 56–60) and EGF ligands in *Drosophila* (61–63). In urochordates, FGF signals on their own may act to induce neural tissue (64). In *N. vectensis* FGF ligands are expressed in both the pharynx and apical sensory tuft (D.Q.M., G.H.T., and M.Q.M., unpublished work), suggesting that neural tissue could be induced where the FGF signals intersect with the BMP inhibitors. This notion is supported by expression of various genes implicated in neural fate specification in the planula apical tuft, a sensory structure at the anterior end of the swimming stage. The apical tuft expresses *NvDpp* and *NvBMP5–8*, and their inhibitor (*NvNoggin1*), and a variety of genes associated with neural tissue including *NvGsc*, *NvNetrin*, *NvCOE* (43), *NvAnthox1* (9), *NvSoxB1*, and *NvFoxD1* (65), some of which are also expressed in the pharynx (*NvGsc*, *NvDpp*, *NvBMP5–8*, *NvNoggin1*) (Fig. 7). Although we have no direct evidence yet, it is tempting to speculate that the asymmetric expression of genes described in this article has the potential to determine the distribution of presumptive nervous elements.

Immunohistochemical studies have shown a great deal of molecular complexity in neuropeptide expression in *Hydra* (66, 67), and gene expression studies with an increasingly broad range of molecular markers with potential roles in neural patterning have highlighted distinct domains of the *N. vectensis* body plan. *NvNetrin*

is expressed in the same longitudinal stripe of body wall where several *Hox* genes are expressed. The circumpharyngeal expression of *N. vectensis* homologs of genes such as *NvNetrin*, *NvGremlin*, *NvNotch1*, *NvNotch2*, and *NvDelta* (H.M., D.Q.M., and M.Q.M., unpublished work), correspond to the location of the nerve ring surrounding the mouth of cnidarians (68). This circumblastoporal concentration of nerves has been suggested to represent a precursor to the bilaterian CNS (69). Asymmetric pharyngeal expression of *NvNoggin1* and *NvAnthox8* could correspond with a dorsal supraesophageal ganglion, whereas a lateral *NvGbx* domain, and the longitudinal *NvAnthox7*, *NvAnthox8*, *NvAnthox1a*, and *NvNetrin* expression confined to a defined strip along the opposite (i.e., ventral) body wall, would then correspond to the layout of the typical protostome CNS (Fig. 7).

Unfortunately, the nervous system of *N. vectensis* is still poorly characterized. Cnidarians have both ectodermal and endodermal “nerve nets” that in hydrozoans are derived from endodermally derived stem cells (70). Most of the asymmetric genes in the pharynx (except for *NvDpp*) are expressed in the pharyngeal (*NvAnthox6*, *NvAnthox8*, *NvNoggin1*, *NvGsc*, *NvGbx*) or body wall (*Anthox7*, *Anthox8*, *Anthox1a*) endoderm. One possibility is that *Hox* and other neural patterning genes were originally involved in endodermal nervous system patterning and were recruited to generate an ectodermally derived definitive CNS in bilaterian descendants. We predict that continued molecular analyses will demonstrate a highly patterned nervous system in *N. vectensis* organized along a bilaterally symmetrical system that belies the animal’s simple morphological appearance.

Conclusions

It is surprising that such a large number of molecular asymmetries exist in an animal that has so little overt morphological complexity. The observation that many of the orthologs of genes expressed asymmetrically in both deuterostomes and protostomes are also asymmetrically expressed in *N. vectensis* suggests that the axial properties of *N. vectensis* could represent features present in the common ancestor of cnidarians and bilaterians. Some of the genes that we have shown to be expressed asymmetrically in *N. vectensis* (*NvGsc*, *NvBMP5–8*) are expressed in radial patterns in radially symmetric hydrozoan cnidarians (36, 71). There is great diversity in the morphological symmetry properties of the Cnidaria. Although some taxa are radially symmetric, many appear bilaterally symmetric or even directionally asymmetric (72). We suggest that the ancestor of cnidarians was originally bilaterally symmetrical, with a clear D-V polarity (along the directive axis) and an anterior–posterior polarity in which the mouth/anus of cnidarians is equivalent to the anterior end of bilaterians (9). Although one might not expect all bilaterian features to be present in an animal derived from

a shared ancestor some half a billion years ago, the expression of important developmental regulatory genes suggest that the bilateral bauplan was established earlier in metazoan history than previously thought.

Materials and Methods

Isolation of Genes from *N. vectensis*. TBLASTN searches of the National Center for Biotechnology Information (NCBI) trace archive of the *N. vectensis* genome (data generated by the Joint Genome Institute) were performed by using metazoan orthologs of bilaterian patterning genes. The traces were then compiled into contigs by using ASSEMBLYLIGN (Accelrys, San Diego, CA) and SEQUENCHER (Gene Codes, Ann Arbor, MI), and ORFs were determined based on BLASTX searches against the nr database at NCBI. Gene-specific primers were then designed for 5' and 3' RACE with annealing temperatures between 68°C and 70°C. RACE was performed by using the Smart Race cDNA amplification kit (BD Biosciences Clontech). RACE products were cloned in a plasmid vector (P-Gem T easy, Promega) and sequenced at Gene Gateway (Hayward, CA). Overlapping 5' and 3' RACE fragments were aligned and submitted to GenBank as composite transcripts.

Phylogenetic Analyses. Phylogenetic analysis of the TGF- β antagonists (noggin, follistatin, and gremlin) and homeodomain genes were performed to determine orthology. Bayesian and neighbor-joining analyses were performed. Additional details concerning

phylogenetic analyses are available in *Supporting Text*, which is published as supporting information on the PNAS web site.

In Situ Hybridization. *In situ* hybridizations using 1- to 3-kb digoxigenin and fluorescein-labeled antisense ribonucleotide probes were performed as described (21). Additional details are available in *Supporting Text*.

Lithium Chloride Experiments. Dejellied embryos were cultured in a 25 mM solution of LiCl in one-third strength times filtered sea water and fixed for *in situ* hybridization (51) at different time points during development.

Xenopus Methods. Synthetic capped mRNA was generated by *in vitro* transcription of linearized plasmids by using appropriate RNA polymerase kits as indicated (mMessage Machine; Ambion, Austin, TX). Plasmid-encoded vector (pGEM-7), *Xenopus* noggin [pSP35-Noggin-Myc; gift of Yoshiki Sasai, Center for Developmental Biology, The Institute of Physical and Chemical Research (RIKEN), Hyogo, Japan], or *N. vectensis* Noggin1 (pGEMT-Easy-NvNog1) were used. A volume of 5–10 nl was injected into 16-cell embryos obtained by *in vitro* fertilization.

We thank Craig Magie (University of Hawaii) for providing the confocal image of an *N. vectensis* planula. G.H.T. thanks W. Lennarz for sabbatical leave from Stony Brook University and members of Kewalo Marine Laboratory for their generosity during his sabbatical. This work was supported by grants from the National Science Foundation and National Aeronautics and Space Administration (to M.Q.M.) and National Institutes of Health Grant HD032429 (to G.H.T.).

- Wallberg, A., Tholleson, M., Farris, J. S. & Jondelius, U. (2004) *Cladistics* **20**, 558–578.
- Wainright, P. O., Hinkle, G., Sogin, M. L. & Stickle, S. K. (1993) *Science* **260**, 340–342.
- Odorico, D. M. & Miller, D. J. (1997) *Proc. Biol. Sci.* **264**, 77–82.
- Collins, A. G., Cartwright, P., McFadden, C. S. & Scheirwater, B. (2005) *Integr. Comp. Biol.* **45**, 585–594.
- Collins, A. G. (2002) *J. Evol. Biol.* **15**, 418–432.
- Beklemishev, V. N. & Kabata, Z. (1969) *Principles of Comparative Anatomy of Invertebrates* (Oliver & Boyd, Edinburgh).
- Delage, Y. & Herouard, E. (1901) *Traité de Zoologie Concrète Les Coelenterates* (Paul Schmidt, Paris).
- Hyman, L. H. (1940) *The Invertebrates: Protozoa through Ctenophora* (McGraw-Hill, New York).
- Finnerty, J. R., Pang, K., Burton, P., Paulson, D. & Martindale, M. Q. (2004) *Science* **304**, 1335–1337.
- De Robertis, E. M. & Sasai, Y. (1996) *Nature* **380**, 37–40.
- De Robertis, E. M. & Kuroda, H. (2004) *Annu. Rev. Cell Dev. Biol.* **20**, 285–308.
- Stathopoulos, A. & Levine, M. (2002) *Dev. Biol.* **246**, 57–67.
- Schneider, S., Steinbeisser, H., Warga, R. M. & Hausen, P. (1996) *Mech. Dev.* **57**, 191–198.
- Steinbeisser, H., Fainsod, A., Niehrs, C., Sasai, Y. & De Robertis, E. M. (1995) *EMBO J.* **14**, 5230–5243.
- De Robertis, E. M., Wessely, O., Oelgeschlager, M., Brizuela, B., Pera, E., Larrain, J., Abreu, J. & Bachiller, D. (2001) *Int. J. Dev. Biol.* **45**, 189–197.
- Rhinn, M., Lun, K., Amores, A., Yan, Y. L., Postlethwait, J. H. & Brand, M. (2003) *Mech. Dev.* **120**, 919–936.
- Izpisua-Belmonte, J. C., De Robertis, E. M., Storey, K. G. & Stern, C. D. (1993) *Cell* **74**, 645–659.
- Kuroda, H., Wessely, O. & De Robertis, E. M. (2004) *PLoS Biol.* **2**, E92.
- Lander, E. S. & Waterman, M. S. (1988) *Genomics* **2**, 231–239.
- Technau, U., Rudd, S., Maxwell, P., Gordon, P. M., Saina, M., Grasso, L. C., Hayward, D. C., Sensen, C. W., Saint, R., Holstein, T. W., et al. (2005) *Trends Genet.* **21**, 633–639.
- Matus, D. Q., Thomsen, G. H. & Martindale, M. Q. (2006) *Curr. Biol.* **16**, 499–505.
- Schier, A. F. (2003) *Annu. Rev. Cell Dev. Biol.* **19**, 589–621.
- Osada, S. I. & Wright, C. V. (1999) *Development (Cambridge, U.K.)* **126**, 3229–3240.
- Mineta, K., Nakazawa, M., Cebria, F., Ikeo, K., Agata, K. & Gojobori, T. (2003) *Proc. Natl. Acad. Sci. USA* **100**, 7666–7671.
- Kortschak, R. D., Samuel, G., Saint, R. & Miller, D. J. (2003) *Curr. Biol.* **13**, 2190–2195.
- Kusserow, A., Pang, K., Sturm, C., Hrouda, M., Lentfer, J., Schmidt, H. A., Technau, U., von Haeseler, A., Hobmayer, B., Martindale, M. Q. & Holstein, T. W. (2005) *Nature* **433**, 156–160.
- Streit, A. & Stern, C. D. (1999) *Trends Genet.* **15**, 20–24.
- Hemmati-Brivanlou, A., Kelly, O. G. & Melton, D. A. (1994) *Cell* **77**, 283–295.
- Robinson, G. W. & Hennighausen, L. (1997) *Development (Cambridge, U.K.)* **124**, 2701–2708.
- Hsu, D. R., Economides, A. N., Wang, X., Eimon, P. M. & Harland, R. M. (1998) *Mol. Cell* **1**, 673–683.
- Lartillot, N., Le Gouar, M. & Adoutte, A. (2002) *Dev. Genes Evol.* **212**, 551–561.
- Goriely, A., Stella, M., Coffinier, C., Kessler, D., Mailhos, C., Dessain, S. & Desplan, C. (1996) *Development (Cambridge, U.K.)* **122**, 1641–1650.
- Angerer, L. M., Oleksyn, D. W., Levine, A. M., Li, X., Klein, W. H. & Angerer, R. C. (2001) *Development (Cambridge, U.K.)* **128**, 4393–4404.
- Arendt, D., Technau, U. & Wittbrodt, J. (2001) *Nature* **409**, 81–85.
- Broun, M., Sokol, S. & Bode, H. R. (1999) *Development (Cambridge, U.K.)* **126**, 5245–5254.
- Culotti, J. G. & Merz, D. C. (1998) *Curr. Opin. Cell Biol.* **10**, 609–613.
- Aisemberg, G. O., Kuhn, J. & Macagno, E. R. (2001) *Dev. Genes Evol.* **211**, 589–596.
- Gan, W. B., Wong, V. Y., Phillips, A., Ma, C., Gershon, T. R. & Macagno, E. R. (1999) *J. Neurobiol.* **40**, 103–115.
- Mitchell, K. J., Doyle, J. L., Serafini, T., Kennedy, T. E., Tessier-Lavigne, M., Goodman, C. S. & Dickson, B. J. (1996) *Neuron* **17**, 203–215.
- Serafini, T., Kennedy, T. E., Galko, M. J., Mirzayan, C., Jessell, T. M. & Tessier-Lavigne, M. (1994) *Cell* **78**, 409–424.
- Shimeld, S. (2000) *Dev. Genes Evol.* **210**, 337–344.
- Gerhart, J. (2000) *Proc. Natl. Acad. Sci. USA* **97**, 4445–4448.
- Pang, K., Matus, D. Q. & Martindale, M. Q. (2004) *Dev. Genes Evol.* **214**, 134–138.
- Herbst, C. (1893) *Mitt. Zool. Station Neapel*, **11**, 136–220.
- Kitazawa, C., Takai, K. K., Nakajima, Y., Fujisawa, H. & Amemiya, S. (2004) *J. Exp. Zool. A. Comp. Exp. Biol.* **301**, 707–717.
- Kao, K. R., Masui, Y. & Ellinson, R. P. (1986) *Nature* **322**, 371–373.
- Kao, K. R. & Ellinson, R. P. (1998) *Biol. Cell* **90**, 585–589.
- Khokha, M. K., Yeh, J., Grammer, T. C. & Harland, R. M. (2005) *Dev. Cell* **8**, 401–411.
- Smith, W. C., Knecht, A. K., Wu, M. & Harland, R. M. (1993) *Nature* **361**, 547–549.
- Martindale, M. Q., Pang, K. & Finnerty, J. R. (2004) *Development (Cambridge, U.K.)* **131**, 2463–2474.
- Fritzenwanker, J. H., Saina, M. & Technau, U. (2004) *Dev. Biol.* **275**, 389–402.
- von Bubnoff, A., Schmidt, J. E. & Kimelman, D. (1996) *Mech. Dev.* **54**, 149–160.
- Martindale, M. Q. (2005) *Nat. Rev. Genet.* **6**, 917–927.
- Altman, C. R. & Brivanlou, A. H. (2001) *Int. Rev. Cytol.* **203**, 447–482.
- Harland, R. (2000) *Curr. Opin. Genet. Dev.* **10**, 357–362.
- Furthauer, M., Van Celst, J., Thisse, C. & Thisse, B. (2004) *Development (Cambridge, U.K.)* **131**, 2853–2864.
- Londin, E. R., Niemiec, J. & Sirotkin, H. I. (2005) *Dev. Biol.* **279**, 1–19.
- Rhinn, M., Picker, A. & Brand, M. (2006) *Curr. Opin. Neurobiol.* **16**, 5–12.
- Wawersik, S., Evola, C. & Whitman, M. (2005) *Dev. Biol.* **277**, 425–442.
- Delaune, E., Lemaire, P. & Kodjabachian, L. (2005) *Development (Cambridge, U.K.)* **132**, 299–310.
- Skeath, J. B. (1998) *Development (Cambridge, U.K.)* **125**, 3301–3312.
- Yagi, Y., Suzuki, T. & Hayashi, S. (1998) *Development (Cambridge, U.K.)* **125**, 3625–3633.
- von Ohlen, T. & Doe, C. Q. (2000) *Dev. Biol.* **224**, 362–372.
- Bertrand, V., Hudson, C., Caillol, D., Popovici, C. & Lemaire, P. (2003) *Cell* **115**, 615–627.
- Magie, C. R., Pang, K. & Martindale, M. Q. (2005) *Dev. Genes Evol.* **215**, 618–630.
- Miljkovic-Licina, M., Gauchat, D. & Galliot, B. (2004) *Biosystems* **76**, 75–87.
- Hansen, G. N., Williamson, M. & Grimmelikhuijzen, C. J. (2002) *Cell Tissue Res.* **308**, 157–165.
- Grimmelikhuijzen, C. J. & Westfall, J. A. (1995) *EXS* **72**, 7–24.
- Nielsen, C. (2005) *Evol. Dev.* **7**, 483–489.
- David, C. N. & Hager, G. (1994) *Perspect. Dev. Neurobiol.* **2**, 135–140.
- Reinhardt, B., Broun, M., Blitz, I. L. & Bode, H. R. (2004) *Dev. Biol.* **267**, 43–59.
- Dunn, C. W. (2005) *Dev. Dyn.* **234**, 835–845.

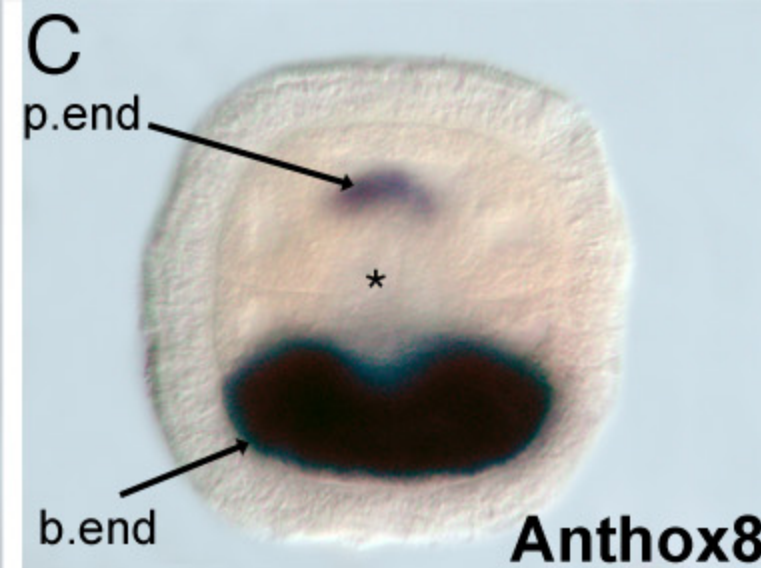
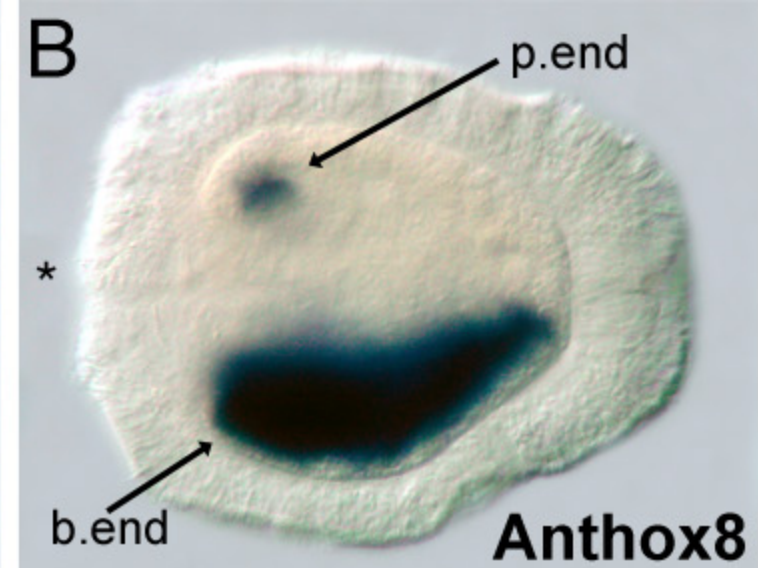
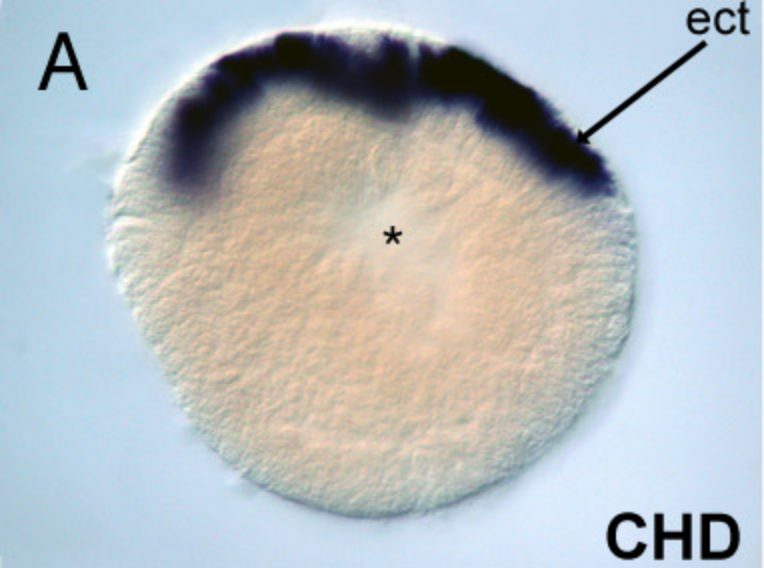

A

Follistatin

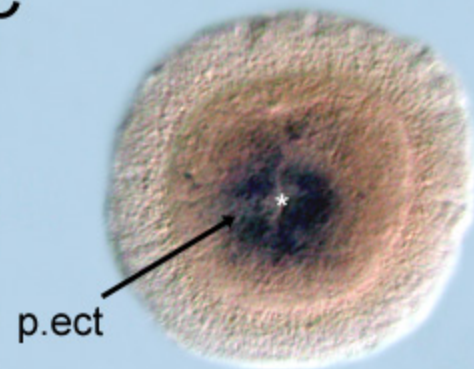
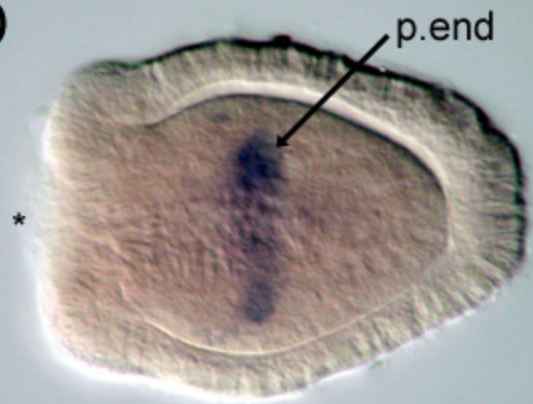
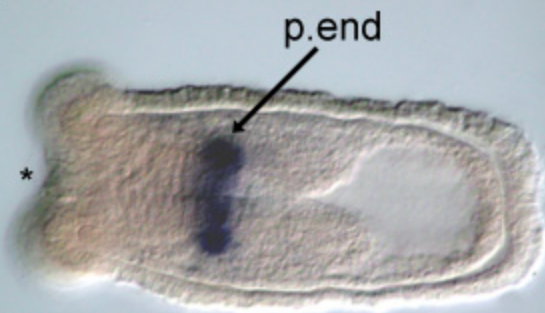
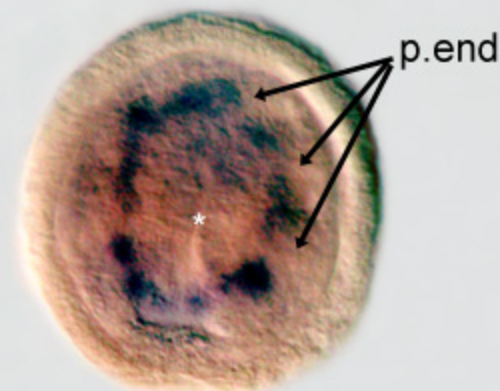
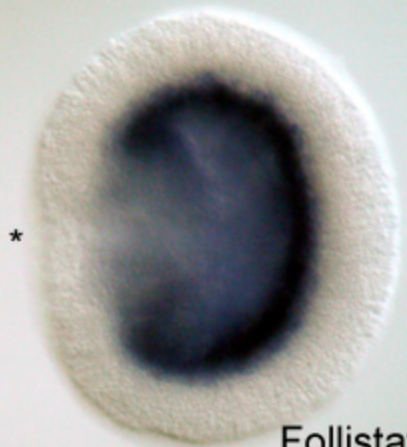
B**C****D****E****F****G**

Follistatin-like

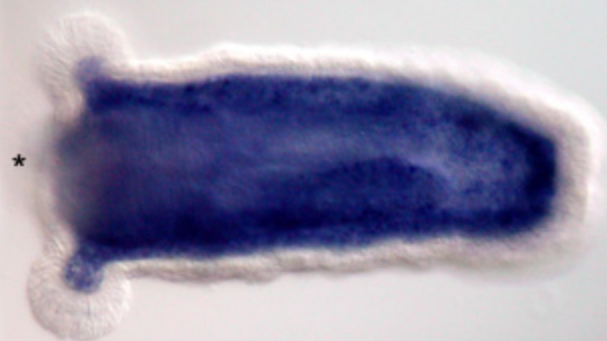
H**I**

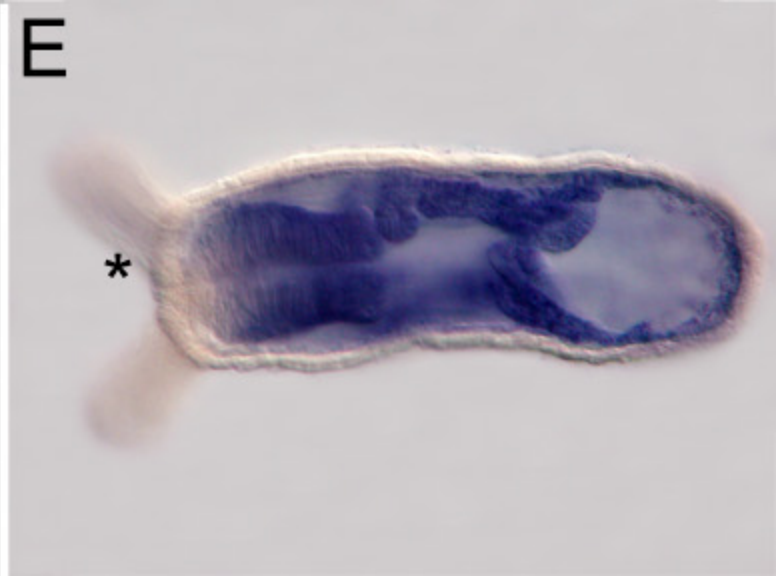

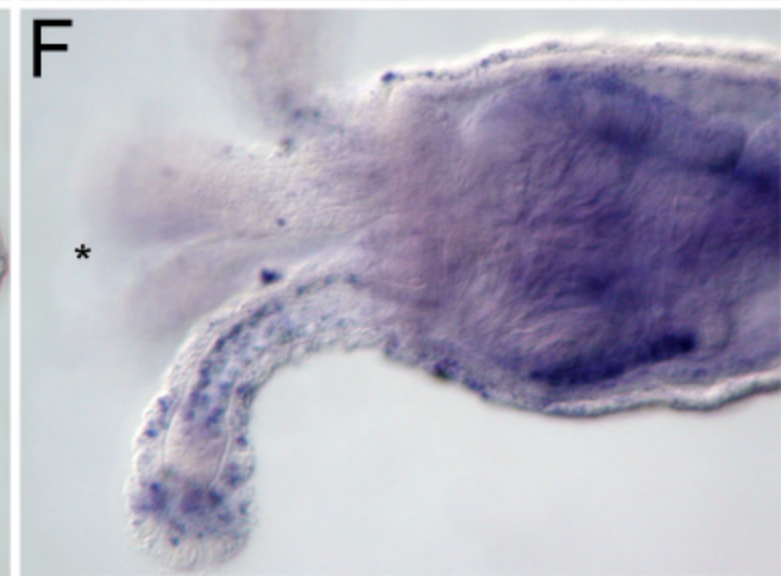
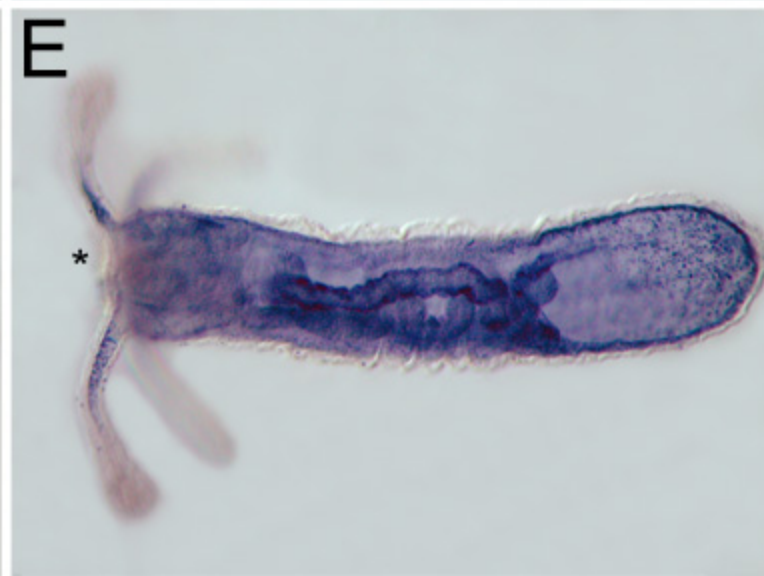
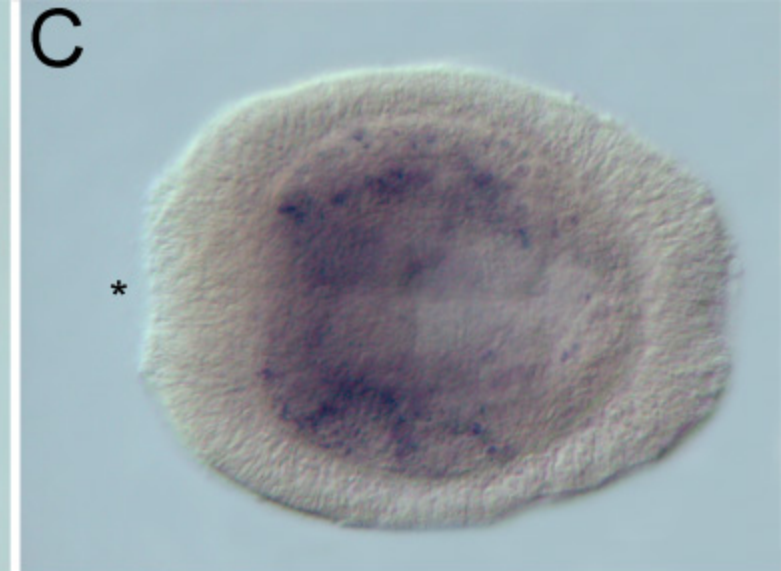
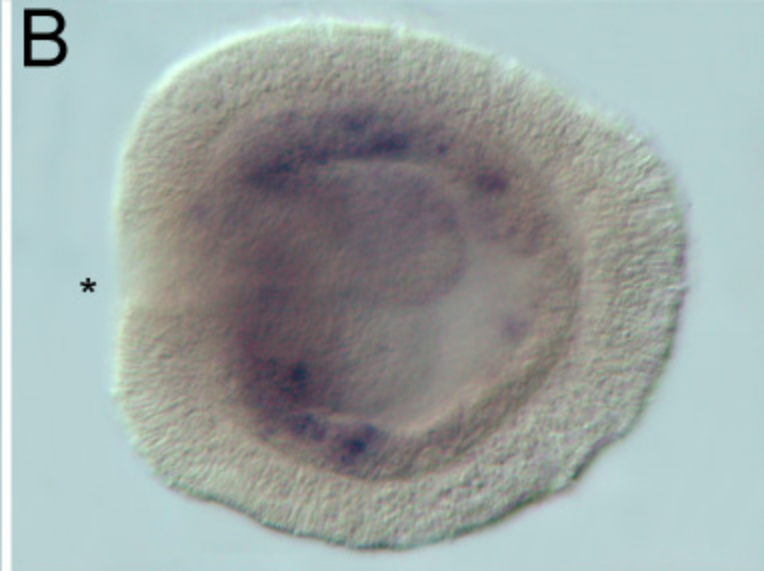

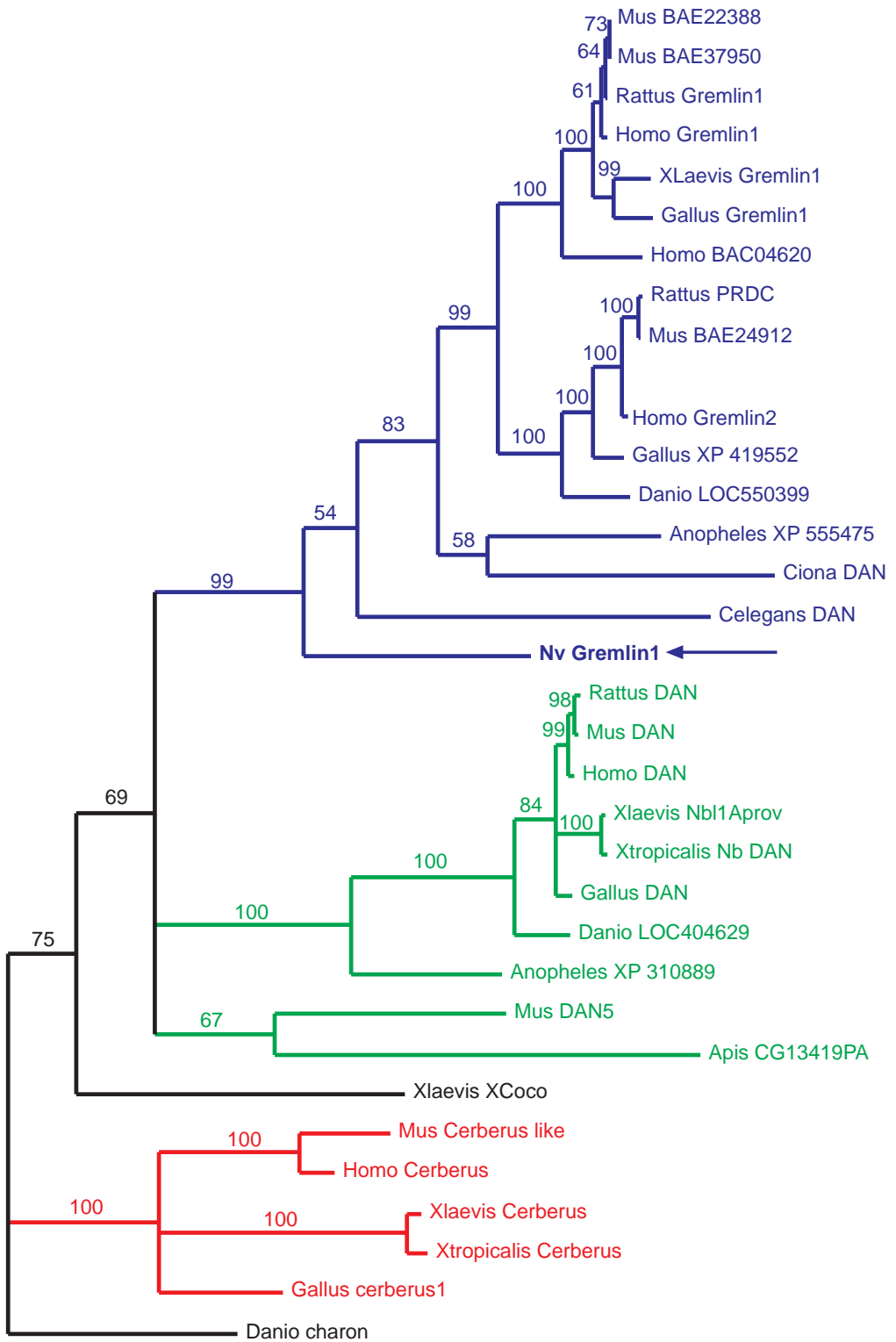

GREMLIN

DAN

Cerberus

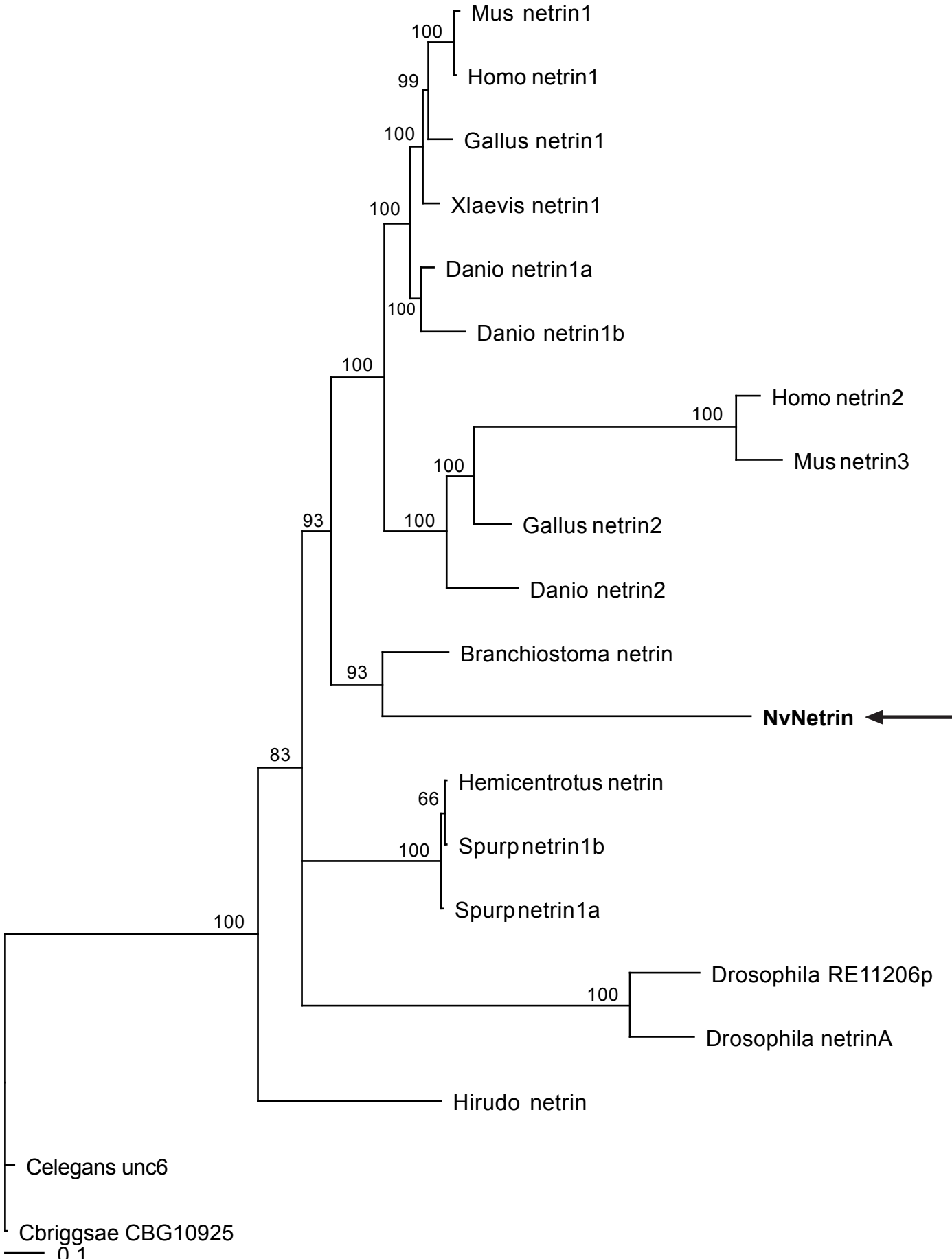

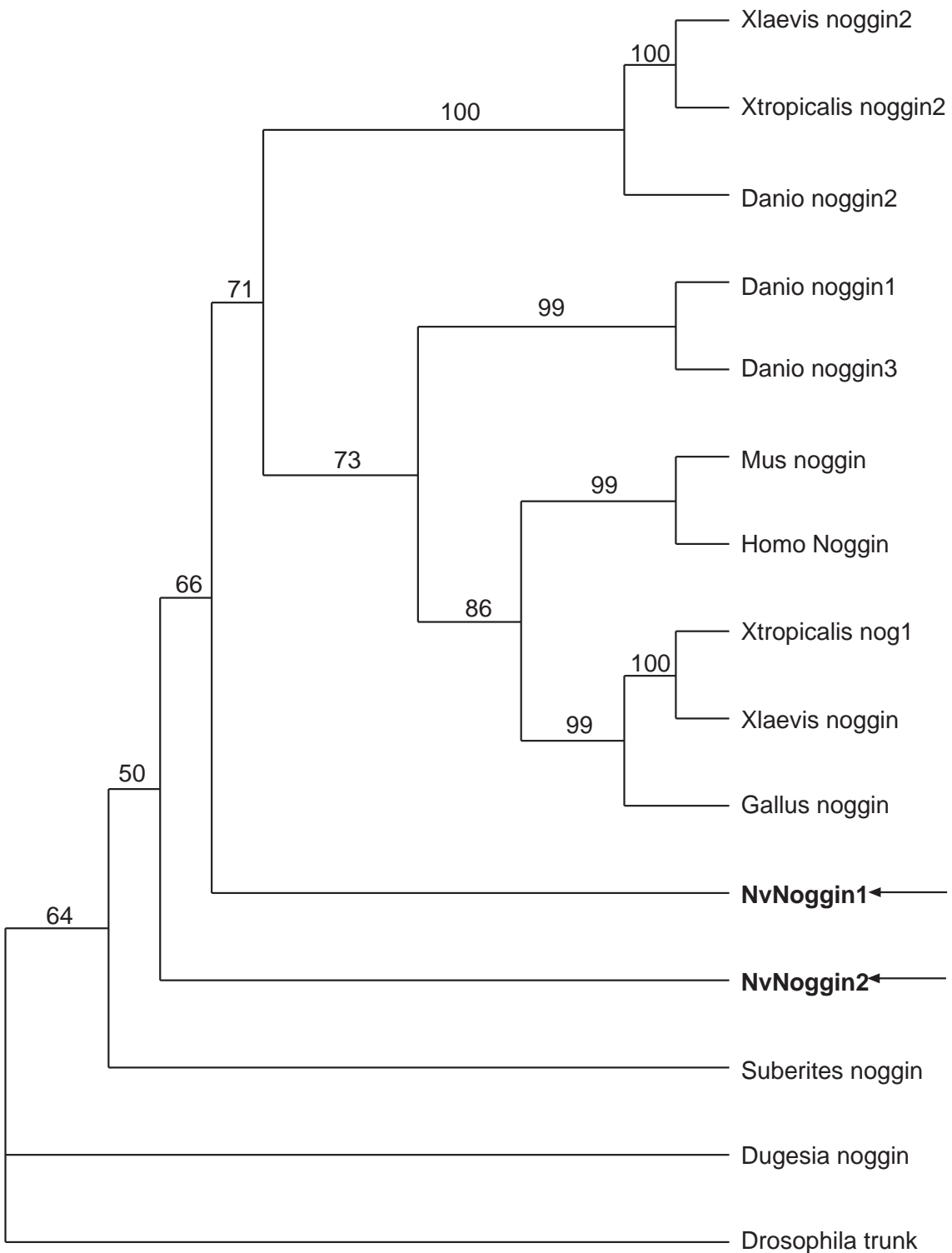

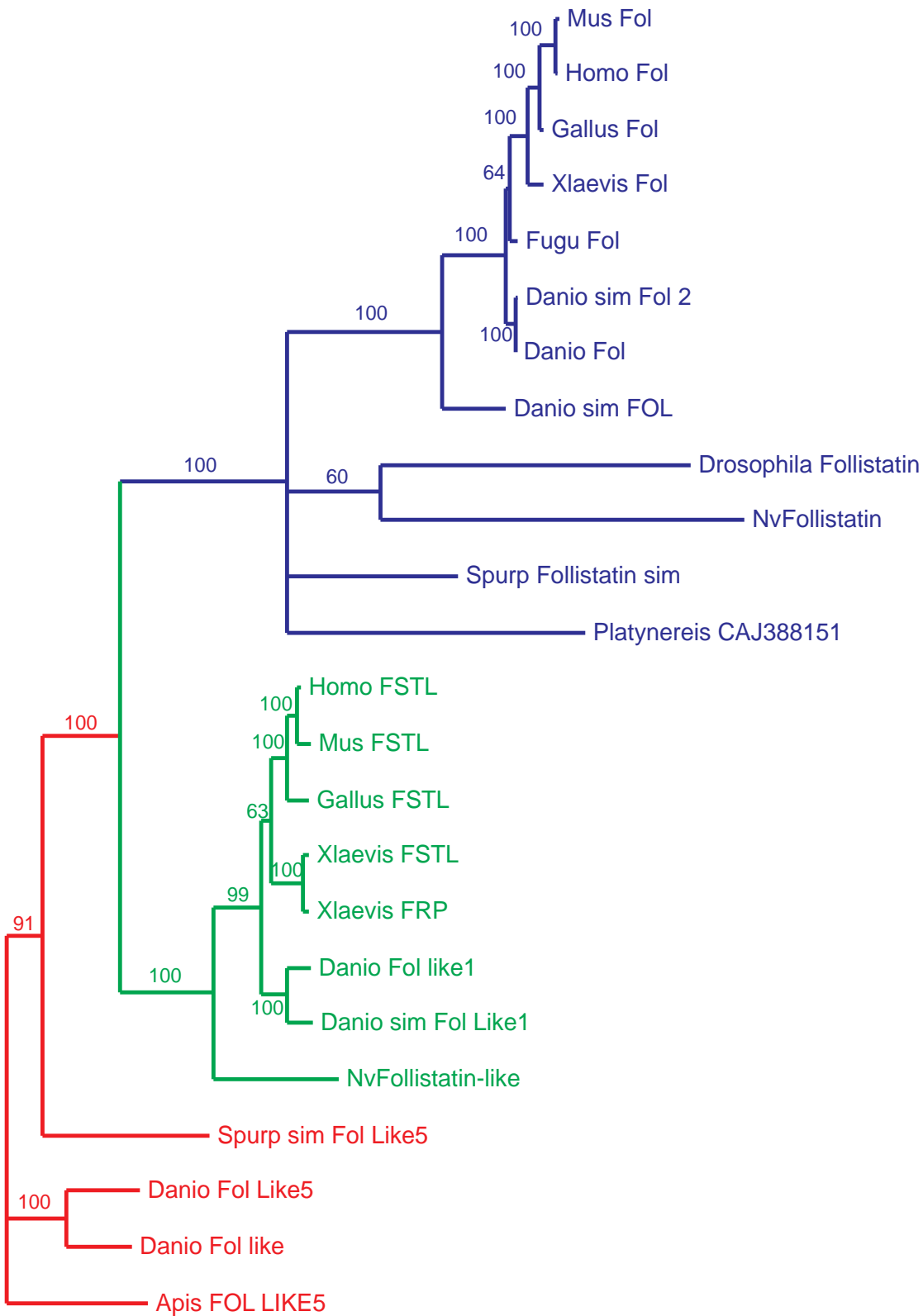

0.1

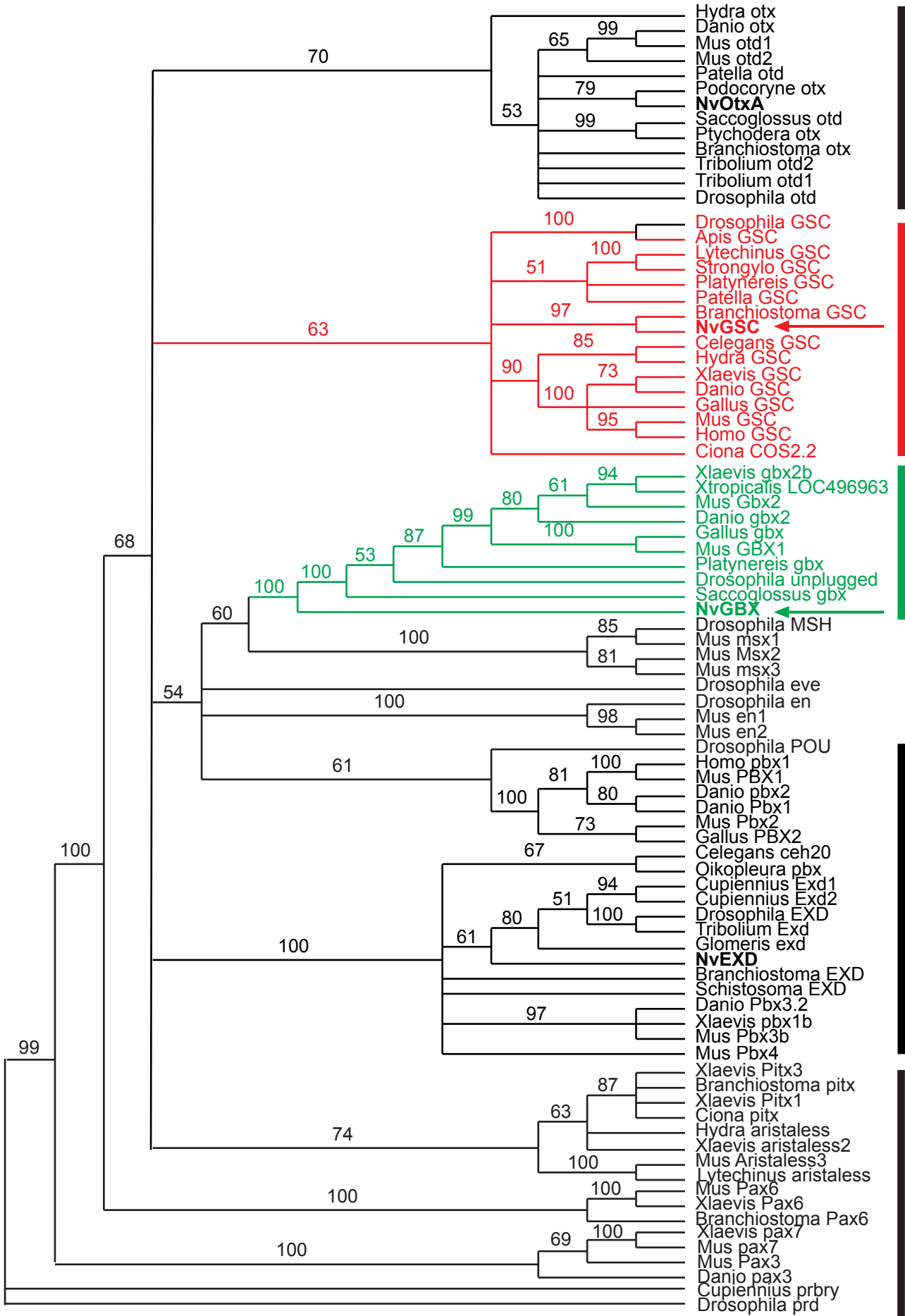

Otx/Otd

Gsc

Gbx

Exd/Pbx

Prd

- Hydra otx
- Danio otx
- Mus otd1
- Mus otd2
- Patella otd
- Podocoryne otx
- NvOtxA**
- Saccoglossus otd
- Ptychodera otx
- Branchiostoma otx
- Tribolium otd2
- Tribolium otd1
- Drosophila otd
- Drosophila GSC
- Apis GSC
- Lytechinus GSC
- Strongylo. GSC
- Platynereis GSC
- Patella GSC
- Branchiostoma GSC
- NvGSC**
- Celegans GSC
- Hydra GSC
- Xlaevis GSC
- Danio GSC
- Gallus GSC
- Mus GSC
- Homo GSC
- Ciona COS2.2
- Xlaevis gbx2b
- Xtropicalis LOC496963
- Mus Gbx2
- Danio gbx2
- Gallus gbx
- Mus GBX1
- Platynereis gbx
- Drosophila unplugged
- Saccoglossus gbx
- NvGBX**
- Drosophila MSH
- Mus msx1
- Mus Msx2
- Mus msx3
- Drosophila eve
- Drosophila en
- Mus en1
- Mus en2
- Drosophila POU
- Homo pbx1
- Mus PBX1
- Danio pbx2
- Danio Pbx1
- Mus Pbx2
- Gallus PBX2
- Celegans ceh20
- Oikopleura pbx
- Cupiennius Exd1
- Cupiennius Exd2
- Drosophila EXD
- Tribolium Exd
- Glomeris exd
- NvEXD**
- Branchiostoma EXD
- Schistosoma EXD
- Danio Pbx3.2
- Xlaevis pbx1b
- Mus Pbx3b
- Mus Pbx4
- Xlaevis Pitx3
- Branchiostoma pitx
- Xlaevis Pitx1
- Ciona pitx
- Hydra aristaless
- Xlaevis aristaless2
- Mus Aristaless3
- Lytechinus aristaless
- Mus Pax6
- Xlaevis Pax6
- Branchiostoma Pax6
- Xlaevis pax7
- Mus pax7
- Mus Pax3
- Danio pax3
- Cupiennius prbrby
- Drosophila prd

Control



XNoggin

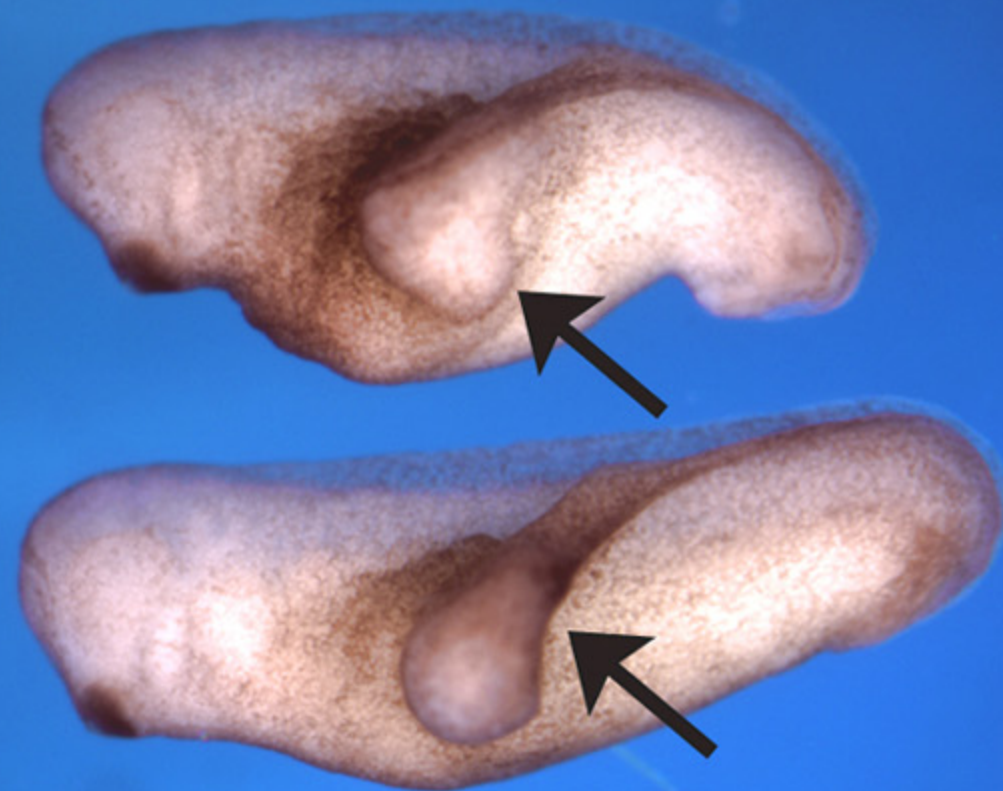

NvNoggin1





Sign up for PNAS Online eTocs

Get notified by email when new content goes on-line

[Info for Authors](#) | [Editorial Board](#) | [About](#) | [Subscribe](#) | [Advertise](#) | [Contact](#) | [Site Map](#)

PNAS

Proceedings of the National Academy of Sciences of the United States of America

[Current Issue](#)

[Archives](#)

[Online Submission](#)

advanced search >>

GO

This Week In PNAS Early Edition

Selected articles appearing the week of July 10

New for July 12

Developmental Biology

- [Bilaterality may have evolved earlier than thought](#)

This Week in PNAS Early Edition

- [Early Edition Table of Contents](#)
- [PNAS in the News](#)
- [This Week in PNAS Early Edition Archive](#)
- [Press Information](#)

Other recent highlights:

Ecology | Sustainability Science

- [Reconsidering past, present, and future bird extinctions](#)

Developmental Biology

Bilaterality may have evolved earlier than thought

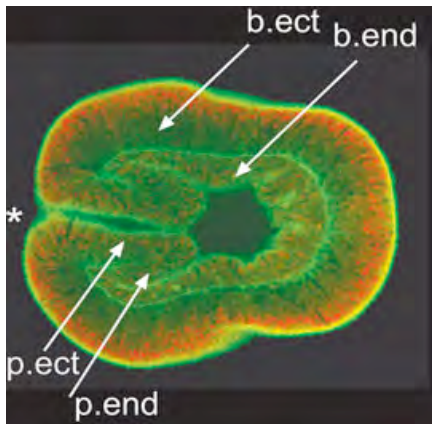

Body plan of anemone *N. vectensis*.

Cnidarians such as jellyfish, corals, and sea anemones are generally radially symmetric, but morphologists have found some species with apparent bilateral symmetry. David Matus *et al.* report that cnidarians control development and produce anatomical bilaterality with some of the same genes as bilateral organisms (bilaterians), suggesting that bilaterality originated much earlier than previously thought. Matus *et al.* found that the starlet sea anemone, *Nematostella vectensis*, uses six genes that bilaterians use to control dorsoventral polarity, despite having a body that is morphologically simple. Two of these genes, *NvGbx* and *NvChordin*, were expressed in a left-right fashion. *N. vectensis*' nervous system has not been fully characterized, but Matus *et al.* predict that it will initially develop as bilaterally symmetric, even though the anemone appears fairly simple to the naked eye. *N. vectensis* may possess a genetic control system that resembles the 500-million-year-old common ancestor of cnidarians and bilaterians, and the authors suggest that the ancestor of cnidarians originally could have been bilateral and subsequently evolved the more radial patterns seen today. — P.D.

"Molecular evidence for deep evolutionary roots of bilaterality in animal development"

by David Q. Matus, Kevin Pang, Heather Marlow, Casey W. Dunn, Gerald H. Thomsen, and Mark Q. Martindale
[\[Full Text\]](#)

▲ Ecology | Sustainability Science

Reconsidering past, present, and future bird extinctions

At present, ~130 of the 10,000 identified species of birds are known to have gone extinct since the year 1500, which results in an estimated bird extinction rate of 26 extinctions per million species per year (26 E/MSY). Stuart Pimm *et al.*, however, suggest that this estimate does not take into account certain key factors. According to the authors, the continual identification of new extinct species from skeletal remains, the consideration of missing bird species that have not yet been declared extinct, and the fact that most species of birds are known only after 1850 and not 1500 would all increase the actual extinction rate. When correcting for these factors, Pimm *et al.* present an updated estimate of 100 E/MSY since 1500, although in recent decades conservation efforts have lowered the value to 50 E/MSY. However, increased rates of habitat loss, as well as more modern threats such as invasive species and climate change, may cause a dramatic increase in extinction in the coming years. In fact, the authors predict a rate of 1,000 E/MSY in the 21st century, which could wipe out 12% of all bird species within 100 years. — N.Z.

"Human impacts on the rates of recent, present, and future bird extinctions"

by Stuart Pimm, Peter Raven, Alan Peterson, Çagan H. Sekercioglu, and Paul R. Ehrlich
[\[Full Text\]](#)

The articles in the Proceedings of the National Academy of Sciences report original research by independent authors and do not necessarily represent the view of the National Academies.

[Current Issue](#) | [Archives](#) | [Online Submission](#) | [Info for Authors](#) | [Editorial Board](#) | [About](#)
[Subscribe](#) | [Advertise](#) | [Contact](#) | [Site Map](#)

[Copyright © 2006 by the National Academy of Sciences](#)